

Ci-EF110/120

Memobus Serial Data to Fiber Optic Converter

ShenZhen Comark Technology Co., Ltd.

Tel: 86-755-26055466

Fax: 86-755-22630031

Post : 518126

Addr: Floor 4, Building G, No.2 Tangxi Industrial

Zone, No. 21, Xijing Road, Gu Shu, Xi Xiang, Bao'An

District, Shenzhen, 518126, P. R. China.

Website: <http://www.comark.cn>

Summary

This series of products is an industrial grade Memobus bus optical fiber converter, providing Memobus serial port, support serial communication based on Memobus, communication rate up to 4Mbps, single / double fiber port network support. Ci-EF110 support one channel optical fiber interface, one channel bus data interface, Ci-EF120 supports two cascaded optical fiber interface, one bus data interface. This product features with industrial grade design, IP40 protection grade, wavy aluminum strengthening shell, 35mmDIN rail installation, DC (18~36V) wide power input (9~18VDC power model customizable), with relay alarm output, power supply redundancy and isolation protection etc.. -40~75 working temperature range, can meet the requirements of a variety of industrial sites, providing convenient optical fiber communication solutions.

Characteristic

- Provide 1 Memobus bus interface, communication rate up to 4Mbps
- Support 1~2 Fiber Optic Ports, ST connector (SC, FC Optional)
- Support Optical Fiber link failure and power error alarm LED indication
- DC (18~36V) dual redundant power input (can be customized with 9~18VDC), With DC1500V voltage isolation and reverse connect protection
- IP40 protection, Metal case (wave grain aluminum reinforce case option), 35mmDIN-Rail Installation
- Operating Temperature: -40°C to 75°C suitable to various Industrial work situation

Specification

Bus data interface

- Memobus Fieldbus 5-pin industrial terminal connection
- Baud Rates: 0~4Mbps
- constant voltage 1000V
- Resistor: the unit has 220 ohms, use corresponding switch to make it to be enable

Optical Interface

- Wave length: multi-mode 850nm、1310 nm; single mode 1310 nm、1550nm

More Reliable Connection, More Intelligent Life

- Fiber type: multi-mode 50/125um、62.5/125um、100/140um; single mode 8.3/125 um、9/125um、10/125um
- Transmission distance: multi-mode 2km, single mode 20km.
- Fiber interface type: ST/SC/FC (optional); ST (standard configuration).
- Single Fiber wavelength: A: Transmit wavelength is single mode 1310nm, then Receive wavelength is 1550nm; B: Transmit wavelength is single mode 1550nm, then Receive wavelength is 1310nm

Power

- DC (18~36V) dual redundant power input (can be customized with 9~18VDC), industrial standard voltage DC24V, consumption is less than 1.5W, With DC1500V voltage isolation and reverse connect protection, adopt 5 cores 5.08mm industrial terminal port (please use industrial standard power, otherwise it will occur unit error or damage).

Protection

- Relay: Fiber link fault alarm
- Contact rating: 1A @24V DC, Industrial Terminal port

Mechanical

- Dimensions (H×D×W): 136mm×104.8mm×52.8mm
- Weight: 800g
- Casing: IP40 protection, wave grain aluminum reinforce case option
- Installation: Wall mounting or DIN rail mounting

Environmental

- Operating Temperature: -40 °C ~75 °C (-40 °C ~85 °C optional)
- Storage Temperature: -40°C~85°C
- Ambient Relative Humidity: 5%~95%(non-condensing)

Warranty

- Warranty Period: 5 years

Certifications

- IEC61000-4-2(ESD): Power ±8KV Contact, ±15KV Air; Relay ±8KV Contact, ±15KV Air; Data Cable ±15KV Air
- IEC61000-4-4(EFT): Power ±2KV, Data Cable ±2KV
- IEC61000-4-5(Surge): Power ±2KV CM/ ±1KV DM, Relay ±2KV CM/ ±1KV DM

- IEC60068-2-27(Shock)
- IEC60068-2-32(Free Fall)
- IEC61000-6-2(General Industrial Standard)
- EN50121-4 (rail transit)

Overall Dimension

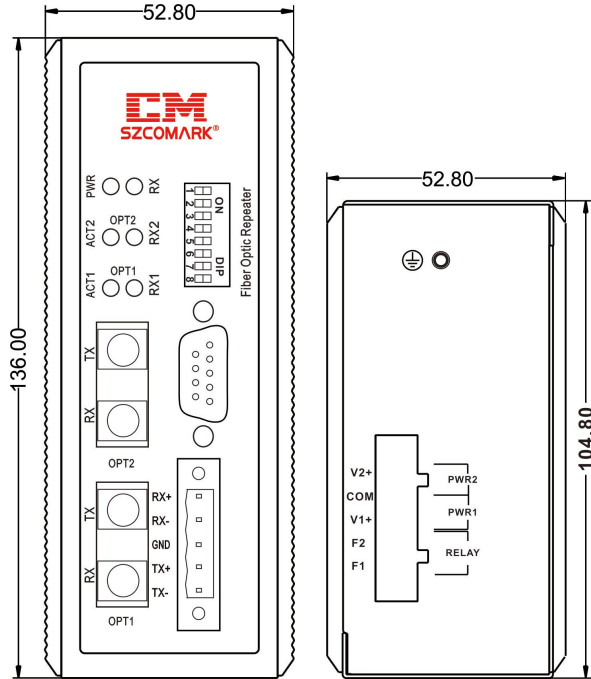

Front view

Top view

LED Indicators

LED	state	Description	Alarm
PWR	off	Non-connect or error	No
	light	Power is ok	No
RX	off	Fieldbus is closed	No
	shine	Copper port is normal, can received data	No
OPT1-2 RX1~2	off	Fiber link is normal, have no Signal	No
	light	Fiber link error	Yes

ACT1~2	shine	Fiber link is normal, have Signal	No
	off	Fiber link is normal	No
	light	Fiber link RX End error	Yes

Terminal Resistor

Resistor is to eliminate the effect of the signal reflected in communication cable, can be connected in the two terminal nodes of the cable as needed. Photoelectric converter is to make cable bus segment, each segment on both ends of the cable can be an external resistor as needed. Please refer to the bus standard resistor connection mode, such as using splitter.

Connection

1. Bus connecting method: Memobus bus signal wires are connected to the 5-Pin terminal Rx+ and Rx-, the bus shield is connected to the GND

Pull-switch settings:

switch setting	S1.1	S1.2	S1.3	S1.4
Memobus	OFF	ON	OFF	ON

Other function settings:

S1.5: bus termination resistor (75 Ω) enable, "ON" indicate connected.

S1.6: NC, set to OFF

S1.7: NC, set to OFF

S1.8: NC, set to OFF

Wiring Diagram:

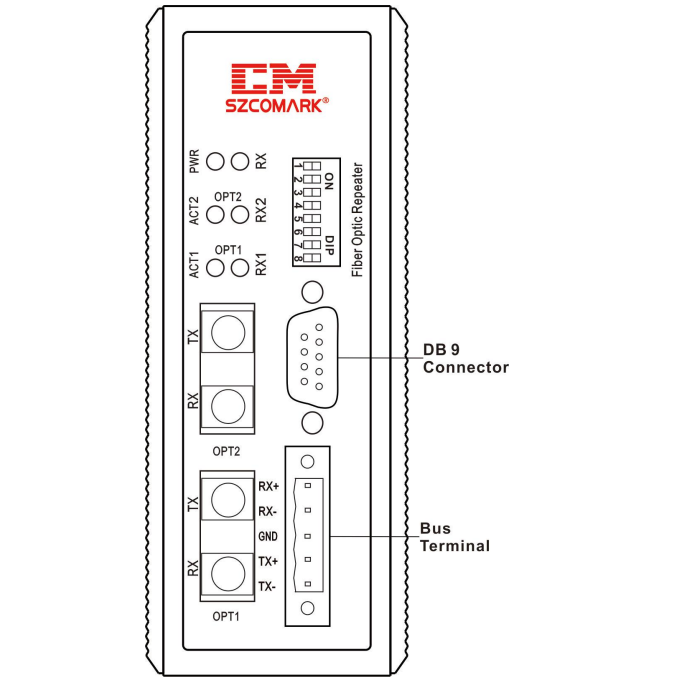

2. Fiber connection methods:

as shown in the figure below, the optical fiber must cross connection, namely the RX connect other side TX, and TX to RX accordingly. Ci-EF110 is one fiber port device, suitable for point-to-point connection; Ci-EF120 is dual fiber port device, suitable for bus network topology, one optical port (OPT1) to connect with front-end equipment, the other optical port (OPT2) with back-end equipment, optical fiber must cross connection.

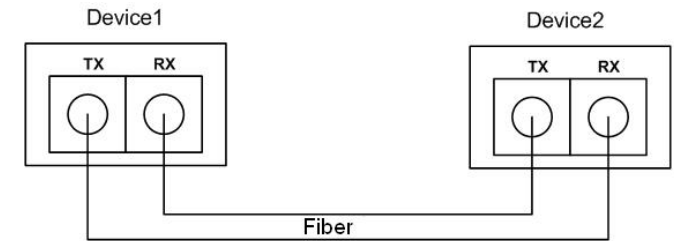

Single Fiber module(single fiber device), as shown in the figure below, single fiber can transmit and receive Signal,. Note, Single fiber use 2 different wavelengths to

transmit and receive signal, and its paired module transmit and receive wavelength is opposite. (Device1 transmit wavelength is 1310nm, receive one is 1550nm; device2 receive wavelength is 1310nm, transmit wavelength is 1550nm.)

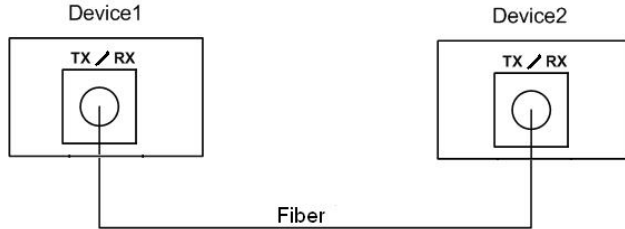

3. Power connection as shown in the figure below, this device supports dual redundant input, V1 +, V2 + respectively connect the anode of power supply (DC18 ~36V), COM with cathode (double power sharing). (can be customized with 9~18VDC)
4. Relay alarm output connection: F1, F2 in normal open. When the alarm is closed, make F1, F2 both contacted in series with external alarm circuit (e.g., buzzer, etc.).(When there is no electricity on device, the relay is closed.)

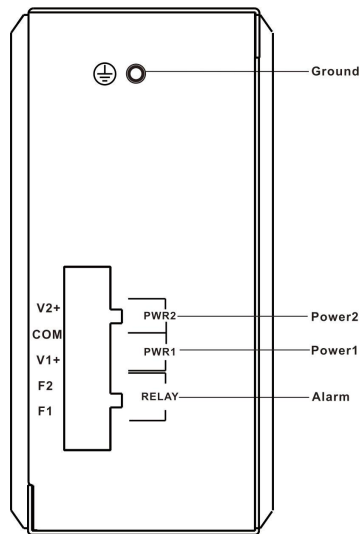

DIN-Rail Installation

In order to use in industrial environments expediently,

Ci-EF110/120 adopt 35mm DIN-Rail installation, the installation steps as follows:

- Step 1: Examine the DIN-Rail attachment
- Step 2: Examine DIN Rail whether be firm and the position is suitability or not.
- Step 3: insert the bottom of the DIN-RAIL into the slot, then insert the top of the DIN-RAIL into the slot.
- Step 4: after insert the DIN-RAIL into the slot, check the device is installed into the slot firmly.

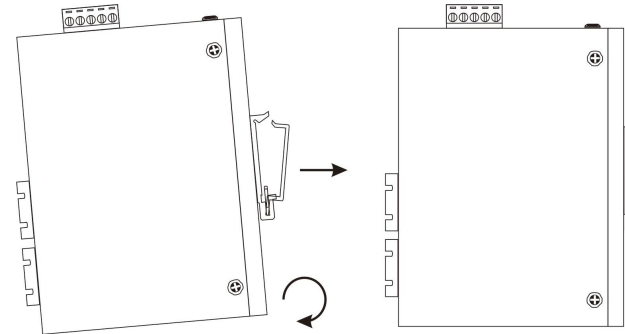

Typical Application

Point to Point

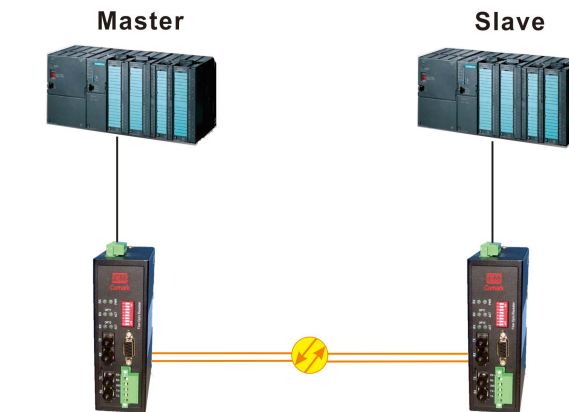

Daisy Chain

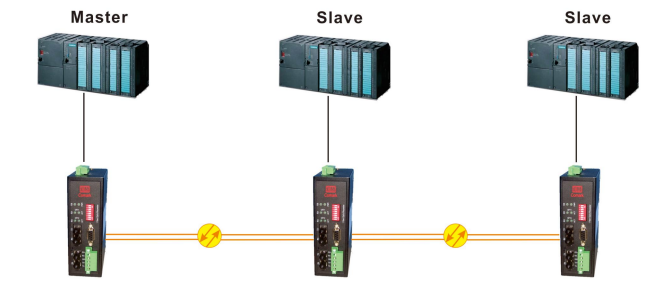

Star Topology

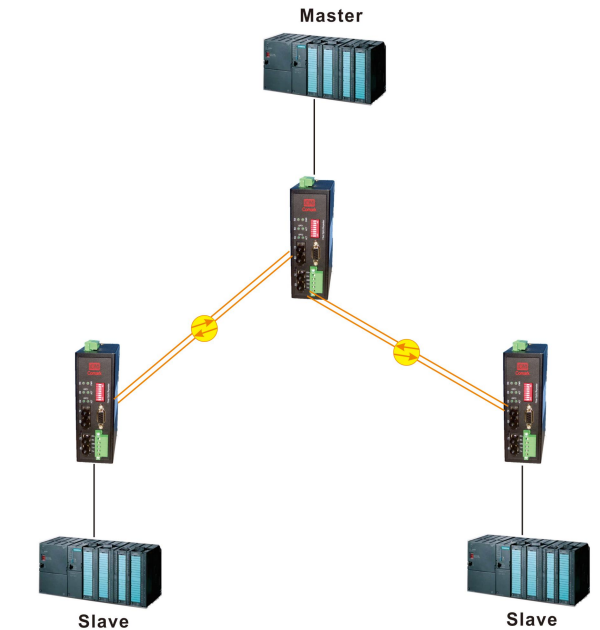

Troubleshooting

Fault Symptoms	What to Do
PWR off	Check and ensure the power supply meets the requirement, and terminal wiring is correct or not.
RX off	Memobus data communication is abnormal, check the connector.
OPT1~2 RX1~2 off butACT1~2on	Check the fiber port connection, the length and type is correct or not.

Package Checklist

Please check accessories completely when open the box.

Packing list is as follows:

- Memobus data fiber optic converter (with industrial terminal block for power equipment)
- Product specification
- Product warranty card

Cautions

- Please use DC24V Industrial standard power(if customized with 9~18VDC, please use DC 12V Industrial standard power). Please use 0.75mm² above quality copper line.
- When relay alarm output, the voltage and current can exceed the rated one(1A@24VDC), otherwise, it will damage the unit.
- When the fiber port is not used, please use fiber cap to cover up to avoid pollute the fiber port.
- Please don't look the device fiber transmit port directly, avoid the light damage eyes.
- This device is precision communication instruction, please insure its ground connection well, the device ground connection is via the landing screw on the sideboard, please use the professional landing line, which is less than 2.5 mm² , and landing resistor is less than 5Ohms.

Order Information

Part No.	Description
Ci-EF110	1 Memobus bus port, 1 Fiber Optic port, (single mode / multi-mode, single fiber / double fiber optional), ST/SC/FC optional, communication rate up to 4Mbps, 9~18vdc power supply customizable.
Ci-EF120	1 Memobus bus port, 2 Fiber Optic port, (single mode / multi-mode, single fiber / double fiber optional), ST/SC/FC optional, communication rate up to 4Mbps, 9~18vdc power supply customizable.